

THANK YOU

Thank you for purchasing a Candy Product

Please read these instructions carefully before using this appliance. The instructions contain important information which will help you get the best out of the appliance and ensure safe and proper installation, use and maintenance.

Keep this manual in a convenient place so you can always refer to it for the safe and proper use of the appliance.

If you sell the appliance, give it away, or leave it behind when you move house, make sure you also pass this manual so that the new owner can become familiar with the appliance and safety warnings.

Legend



Warning - Important Safety information



General information and tips



Environmental information



NOTE: FOR U.K. ONLY

On receipt of your appliance please check it carefully for damage. Any damage found must be reported to the delivery driver immediately. Alternatively damage found must be reported to the retailer within 2 days of receipt.

Environmental conditions



This appliance is marked according to the European directive 2012/19/EU on Waste Electrical and Electronic Equipment (WEEE).

WEEE contains both polluting substances (which can cause negative consequences for the environment) and basic components (which can be re-used). It is important to have WEEE subjected to specific treatments, in order to remove and dispose properly all pollutants, and recover and recycle all materials. Individuals can play an important role in ensuring that WEEE does not become an environmental issue; it is essential to follow some basic rules:

- WEEE should not be treated as household waste;
- WEEE should be handed over to the relevant collection points managed by the municipality or by registered companies. In many countries, for large WEEE, home collection could be present.

In many countries, when you buy a new appliance, the old one may be returned to the retailer who has to collect it free of charge on a one-to-one basis, as long as the equipment is of equivalent type and has the same functions as the supplied equipment.



WARNING!

Risk of injury or suffocation!

Disconnect the appliance from the mains supply. Cut off the mains cable and dispose of it. Remove the door catch to prevent children and pets to get closed in the appliance.

Contents

1. SAFETY INFORMATION
2. INSTALLATION
3. PRACTICAL HINTS
4. PRODUCT DESCRIPTION
5. CONTROL PANEL
6. PROGRAMMES
7. CONSUMPTION
8. DAILY USE
9. REMOTE CONTROL (WI-FI)
10. CARE AND CLEANING
11. TROUBLESHOOTING
12. TECHNICAL DATA
13. CUSTOMER SERVICE

1. SAFETY INFORMATION

Before switching on the appliance for the first time read the following safety hints!



WARNING!

Daily use

- This appliance is intended to be used in household and similar applications such as:
 - Staff kitchen areas in shops, offices and other working environments;
 - Farm houses;
 - By clients in hotels, motels and other residential type environments;
 - Bed and breakfast type environments.
 A different use of this appliance from household environment or from typical housekeeping functions, as commercial use by expert or trained users, is excluded even in the above applications. If the appliance is used in a manner inconsistent with this it may reduce the life of the appliance and may void the manufacturer's warranty. Any damage to the appliance or other damage or loss arising through use that is not consistent with domestic or household use (even if located in a domestic or household environment) shall not be accepted by the manufacturer to the fullest extent permitted by law.
- This appliance can be used by children aged from 8 years and above and persons with reduced physical, sensory or mental capabilities or lack of experience and knowledge if they have been given supervision or instruction concerning use of the appliance in a safe way and understand the hazards involved.
- Children should be supervised to ensure that they do not play with the appliance.
- Children of less than 3 years should be kept away unless continuously supervised.
- If the supply cord is damaged, it must be replaced by a special cord or assembly available from the manufacturer or its service agent.

- Only use the hose-sets supplied with the appliance for the water supply connection (do not reuse old hose-sets).
- Water pressure must be between 0.03 MPa and 1 MPa.
- Make sure carpets or rugs do not obstruct the base or any of the ventilation openings.
- After installation, the appliance must be positioned so that the plug is accessible.
- The maximum load capacity of dry clothes depends on the model used (see control panel).
- To consult the product technical specification please refer to the manufacturer website.

Electrical connections and safety instructions

- The technical details (supply voltage and power input) are indicated on the product rating plate.
- Make sure that the electrical system is earthed, complies with all applicable law and that the (electricity) socket is compatible with the plug of the appliance. Otherwise, seek qualified professional assistance.
- The use of converters, multiple sockets or extension cords is strongly advised against.
- Before cleaning or maintaining the washing machine, unplug the appliance and turn off the water tap.
- Do not pull on the power cord or appliance to unplug the machine.
- Make sure there is no water in the drum before opening the door.



WARNING!

Water may reach very high temperatures during the wash cycle.

- Do not expose the washing machine to rain, direct sunlight or other weather elements. Protect from possible freezing.
- When moving, do not lift the washing machine by the knobs or detergent drawer; during transport, never rest the door on the trolley. We recommend two people lift the washing machine.
- In the event of fault and/or malfunction, turn off the washing machine, close the water tap and do not tamper with the appliance.
- Immediately contact the customer service centre and only use original spare parts. Failure to observe these instructions may jeopardise appliance safety.

Intended use

This appliance is intended for washing machine-washable laundry only. Anytime follow the instructions given on the label of each garment label. It is designed exclusively for domestic use inside the house. It is not intended for commercial or industrial use.

Changes or modifications to the device are not allowed. Unintended use may cause hazards and loss of all warranty and liability claims.

2. INSTALLATION

Preparation

- Make sure there is no transport damage.
- Make sure all transport bolts are removed.
- Handle the appliance always with at least two persons because it is heavy.
- Take the appliance out of the packaging.
- Remove all packaging material including protecting film on cabinet, polystyrene base, keep them out of children reach. While opening the package, water drops may be seen on plastic bag and porthole. This normal phenomenon results from water tests in the factory.



Note: Packaging disposal

Keep all packaging materials out of children's reach and dispose them in an environmentally friendly manner.

OPTIONAL: Install noise reduction pads

1. When opening the shrink package, you will find four noise reduction pads. These are used for reducing noise (Fig. 2-1).
2. Lay the washing machine down to its side, porthole pointing upwards, bottom side towards operator.
3. Take out the noise reduction pads and remove the double-sided adhesive protective film; paste around the bottom: the noise reduction pads under the washing machine cabinet as shown in Fig. 2-1 (two longer pads in position 1 and 3, two shorter pads in position 2 and 4). Finally set the machine upright again.

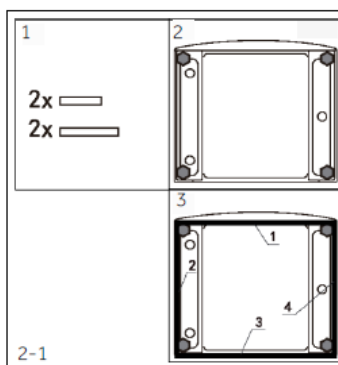

Dismantle the transportation bolts

The transport protection on the rear side is designed for clamping anti-vibration components inside the appliance during transportation to prevent inner damage. All elements (T1, T2, T3 and T4, Fig. 2-2) must be removed before use.

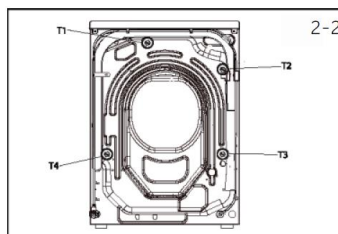

1. Remove all 4 bolts (T1 - T4) (Fig. 2-3).
2. Fill the 5 holes with blanking plugs.



Note: Keep in safe place

Keep all parts of the transport protection in a safe place for later use. Whenever the appliance is to be moved at first reinstall the protection parts.

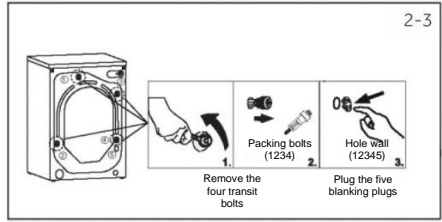

Moving the appliance

If the machine is to be moved to a distant location, replace the transportation bolts removed before installation to prevent damage: The assembly takes place in reverse order.

Aligning the appliance

Adjust all feet (Fig. 2-4) to achieve a complete level position. This will minimize vibrations and thus noise during use. It will also reduce wear and tear. We recommend to use a spirit level for adjustment. Floor should be as stable and flat as possible.

1. Loose the locknut (1) by using a wrench.
2. Adjust the high turning the foot (2).
3. Tighten locknut (1) against the housing.

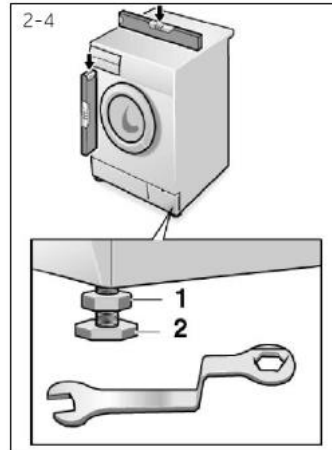

Aligning the appliance

Fix the water drain hose properly to the piping. The hose has to reach at one point a height between 80 and 100 cm above the appliance bottom line! If possible, keep always drain hose fixed to the clip at the appliance back.



WARNING!

- Use only the supplied hose set for the connection.
- Never reuse old hose sets!
- Only connect to cold water supply.
- Before connection, check whether the water is clean and clear.

Following connections are possible:

Drain hose to sink

- Hang the drain hose with the U-support over the edge of a sink with adequate size (Fig. 2-5).
- Protect the U-support sufficiently against slipping.

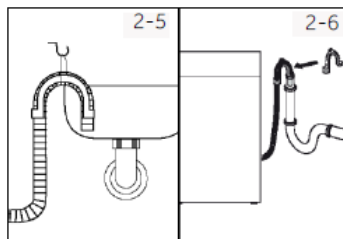

Drain hose to waste water connection

- The internal diameter of the stand pipe with vent-hole must be minimum 40 mm.
- Put the drain hose for 80-100 mm in the wastewater pipe.
- Attach the U-support and secure it sufficiently (Fig. 2-6).

Drain hose to sink connection

- The Junction must lie above the siphon.
- A spigot connection is usually closed by a pad (A). That must be removed to prevent any disfunction (Fig. 2-7).
- Secure the drain hose with a clamp.

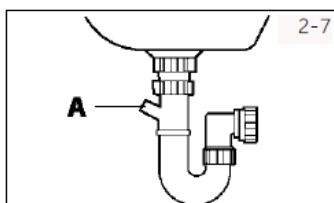

CAUTION!

- The drain hose should not be submerged in water and should be securely fixed and leak-free. If the drain hose is placed on the ground or if the pipe is at a height of less than 80 cm. the washing machine will continuously drain while being filled (self-siphoning).
- Drain hose is not to be extended. If necessary, contact after sales service.

Inlet hose to sink connection

Make sure that the gaskets are inserted.

1. Connect the water inlet hose with the angled end to the appliance (Fig. 2-8). Tighten the screw Joint by hand.
2. Connect the other end to a water tap with a 3/4 thread (Fig. 2-9).

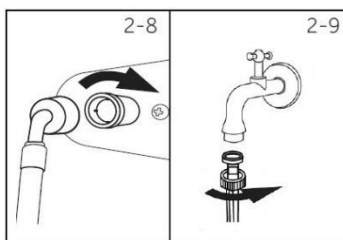

Electrical Connection

Before each connection check if:

- power supply, socket and fusing are appropriate to the rating plate.
- the power socket is earthed and no multi-plug or extension are used.
- the power plug and socket are strictly according.
- **Only UK:** The UK plug meets BS1363A standard. Put the plug into the socket (Fig. 2-10).



WARNING!

- Ensure always that all connections (power supply, drain and fresh water hose) are firm, dry and leak free!
- Take care these parts are never to be crushed, kinked, or twisted.
- If the supply cord is damaged, it must be replaced by the service agent (see warranty card) in order to avoid a hazard.

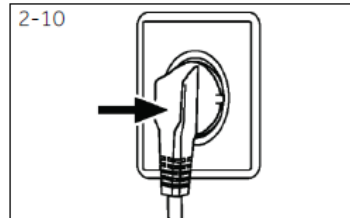

3. PRACTICAL HINTS

Load tips

When sorting laundry, make sure:

- have eliminated metallic objects such as hair clips, pins, coins, from laundry;
- to have buttoned pillow cases, closed zips, tied loose belts and long robe ribbons;
- to have removed rollers, hooks or clips from curtains;
- to have carefully read clothing washing labels;
- to have removed any persistent stains using specific detergents.
- When washing rugs, bedcovers or other heavy clothing, we recommend you avoid the spinning cycle.
- To wash wool, make sure the item can be machine washed. Check the fabric label.
- Leave the appliance's door slightly open between washes, to prevent possible bad smells developing inside the machine.

Useful advice for saving

Tips on how to save money and not damage the environment when using your appliance.

- Load the machine with suggested capacity shown in the programme table for each programme - this will allow you to SAVE energy and water.
- Noise and residual laundry moisture are affected by spin speed: a faster spin is associated with greater noise and lower residual moisture in the laundry.
- The most efficient programmes in terms of combined use of water and energy are usually the longer-lasting ones with lower temperature.
- Scan QR code on energy label for energy consumption information. The actual energy consumption may differ from the declared one according to local conditions.

Maximise the load size

- Achieve the best use of energy, water, detergent and time by using the recommended maximum load size.
Save up to 50% energy by washing a full load instead of 2 half loads.

Do you need to pre-wash?

- For heavily soiled laundry only' SAVE detergent, time, water and energy consumption by NOT selecting Prewash for slight to normally soiled laundry.

Is a hot wash required?

- Pretreat stains with stain remover or soak dried in stains in water before washing to reduce the necessity of a hot wash programme. Save energy by using a low temperature wash programme.

Dosing the detergent

Below is a short guide with tips and advice on the use of detergent.

- Only use detergents suitable for washing machine.
- Select your detergent according to the type of fabric (cotton, delicates, synthetics, wool, silk, etc.), the colour, the type and level of soiling and the programmed washing temperature.
- To use the right amount of detergent, softener or any other additives, carefully follow.

The manufacturer's instructions every time: correctly using the appliance with the right dose allow you to avoid waste and to reduce the environmental impact.



Note:

When washing heavily soiled whites, we recommend using cotton programs of 60 °C or above and a normal washing powder (heavy duty) that contains bleaching agents that at medium/high temperatures provide excellent results. For washes between 40°C and 60°C the type of detergent used needs to be appropriate for the type of fabric and level of soiling. Normal powders are suitable for "white" or colour fast fabrics with high soiling, while liquid detergents or "colour protecting" powders are suitable for coloured fabrics with light levels of soiling.

For washing at temperatures below 40 °C, we recommend the use of liquid detergents or detergents specifically labeled as suitable for low temperature washing.

For washing wool or silk, only use detergents specifically formulated for these fabrics.

- Too much detergent leads to excessive foam, which prevents the cycle being carried out correctly. It could also affect the quality of the washing and rinsing.

The use of ecological detergents without phosphates may cause the following effects:

- **cloudier rinse drain water:** This effect is tied to the suspended zeolites which do not have negative effects on rinse efficiency.
- **white powder (zeolites) on laundry at the end of the wash:** this is normal, the powder is not absorbed by fabric and does not change its colour. To remove the zeolites, select a rinse programme. In the future consider using slightly less detergent.
- **foam in the water at last rinse:** this does not necessary indicate poor rinsing. Consider using less detergent in future washes.
- **abundant foam:** This is often due to the anionic surfactants found in the detergents which are hard to eliminate from laundry. In this case, do not re-rinse to eliminate these effects. It is invalid. We suggest conducting a maintenance wash using a proprietary cleaner. If the problem persists or if you suspect a malfunction, immediately contact an Authorised Customer Service Centre.

4. PRODUCT DESCRIPTION



Note:

Due to technical changes and different models, the illustrations in the following chapters may differ from your model.

Picture of appliance

Front (Fig. 4-1):

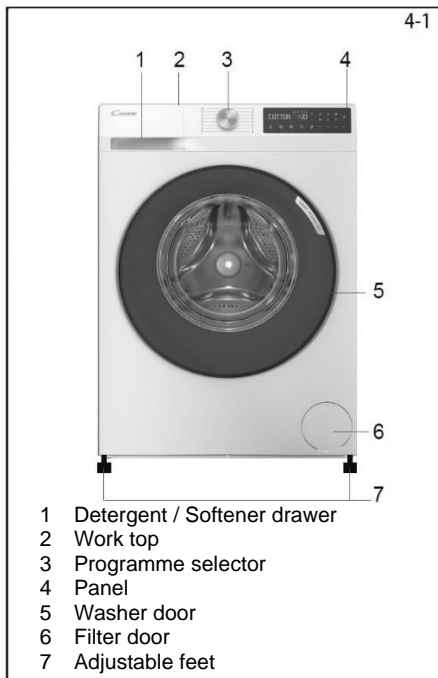

Rear side (Fig. 4-2):

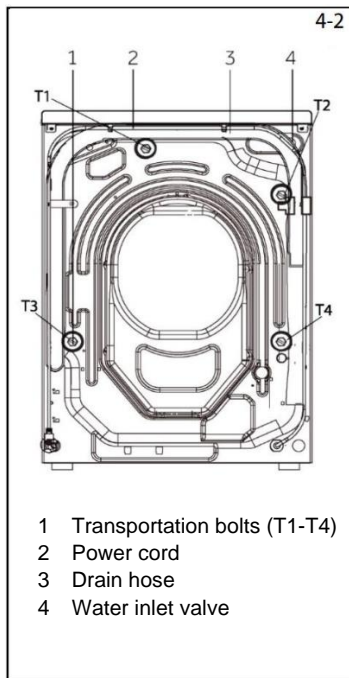

Accessories

Check the accessories and literature in accordance with this list (Fig. 4-3)

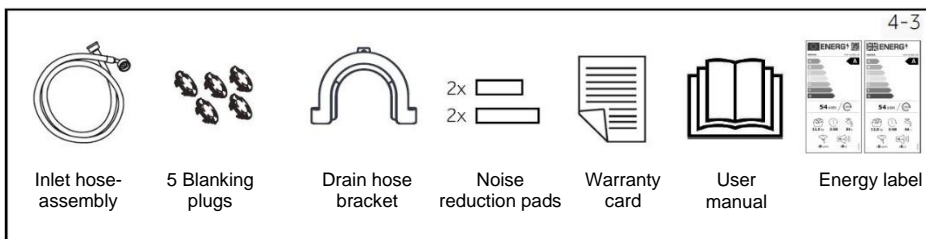

5. CONTROL PANEL

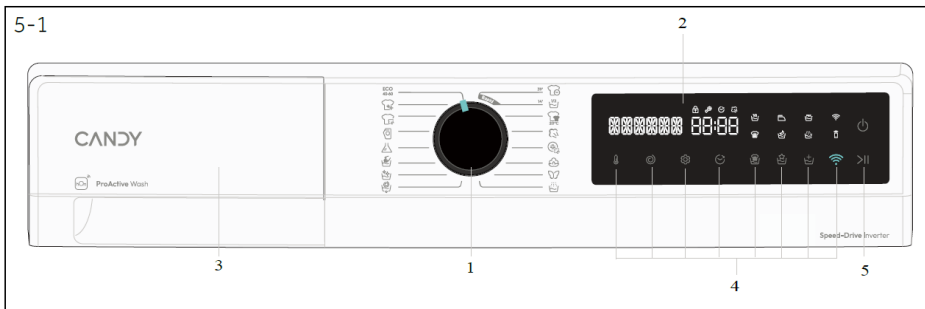

- 1 Programme selector
- 2 Display
- 3 Detergent /Softener drawer
- 4 Function buttons
- 5 "Start/Pause" button



Note: Acoustic signal

The acoustic signal can be selected or canceled if necessary; see <8. DAILY USE>.

Power button

Turn on/ off the machine through this power button (Fig. 5-2).

Programme selector

By turning the knob (Fig. 5-3) one of 16 programmes can be selected, its default settings will be displayed.

Display

The display (Fig. 5-4) shows following information:

- Program name
- Remaining time
- Reservation remaining time
- Alarm information and prompt information
- Pause end information
- Delay time

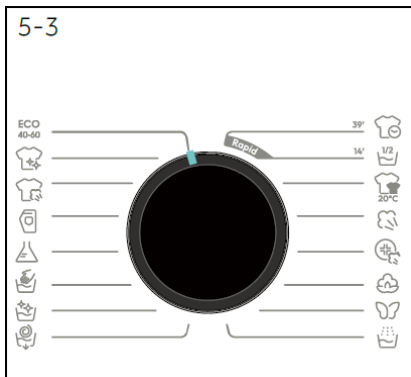

Detergent drawer

Open dispenser drawer, the following components can be seen (Fig. 5-5):

1. Compartment for powder or liquid detergent.
2. Detergent flap selector, lift it up for powder detergent. keep it down for liquid detergent.
3. Put a small amount of washing powder.
4. Compartment for softener.
5. Lock tab. press it down to pull out dispenser drawer.

The recommendation on the type of detergents is suitable for the various washing temperatures, please refer to the manual of detergent (see <ADDING DETERGENT>).

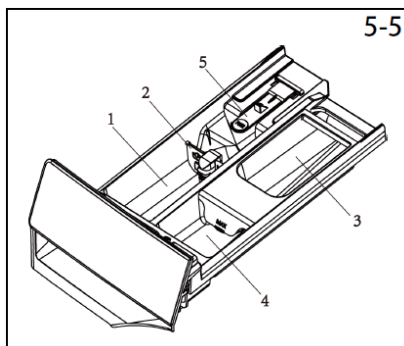

Function buttons

The function buttons (Fig. 5-6) enable additional options in the selected programme before programme starts. The related indicators are displayed.

By switching off the appliance or setting a new programme, all options are displayed. If a button has multiple options, the desired option can be selected by pressing the button sequentially.

By touching the buttons, when it is in dull light, the function is unselected: when it is in bright light, the function is selected.

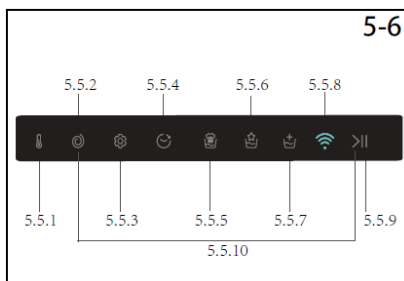

Note: Factory settings

To get best results in each programme Candy has well defined specific default settings. If there is no special requirement default settings are recommended.

Function button “”

- Touch this button (Fig. 5-7) to display the corresponding temperature.
If “0” is selected, the water will not be heated.

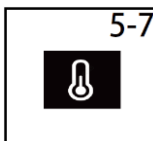

Function button “”

- Touch this button (Fig. 5-8) to change or deselect the spin of programme.
If no light is illuminated and display “---- --”, the laundry will not spin.

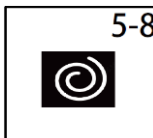

Function button “”

- Touch this button (Fig. 5-9), the screen will display “TURN THE DIAL AND PRESS THE SETUP KEY TO CONFIRM”. Languages and beep types can be selected by the knob.
- Touch the start/stop button, the screen will display “LANGUAGE”. Click again to display the language type, such as ENGLISH. Switch the language types by the knob, and touch the start/stop button again to confirm it.
- Touch display for buzzing sound is “VOICE”, then touch the start/stop button to jet the buzzing. Rotate the knob to display “ON” or “OFF” and touch start/stop button again to confirm.

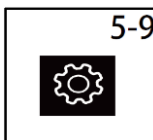

Function button “”

- This button (Fig. 5-10) allows you to preprogramme the wash cycle to with a maximum of 24 hours delay.
- To delay the start use the following procedure:
 - Select the required programme.
 - Press the button once to activate the delay start and then press it again to set the desired delay. The delay increases in steps of 30 minutes, with a maximum of 24 hours delay.
 - Confirm by pressing the START/PAUSE button. The delay countdown will begin and when it has finished, the programme will start automatically.
- It is possible to cancel the delay start by turning the programme selector.



Function button “1/2” “” “” “”

- The first button (Fig. 5-11) is quick wash, which used for situations with less load or dirt.
- The second button is intensive wash, which used for situations with high loads or dirty conditions, and the washing time will be longer.
- Quick wash and intensive wash can not run simultaneously.



Function button “” “” “”

- The laundry keep immersed in water after the final rinse to spread the fiber perfectly. Selecting this program (Fig. 5-12) will turn off the beep and reduce the spin speed except for the alarm. During the water retention phase, the machine will pause the timing. Press start to end the cycle with the spin and drain phase.

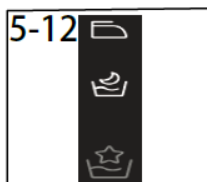

Function button “PRE” “” “”

PREWASH “”

This option (Fig. 5-13) allows you to make a prewash and it is particularly useful for heavily soiled loads (only can be used on some programmes shown in the table).

We recommend you use no or a small amount of detergent shown on the detergent pack.

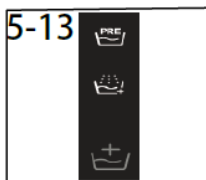

EXTRA RINSE “”



This option (Fig. 5-13) allows you to add one rinse at the end of the washing cycle. It is useful for people with delicate and sensitive skin, for which a small amount of residue may cause allergies. It is advisable to use this program for children clothes and for the washing of heavily soiled items, which require a large amount of detergent or for the washing of toweling items, whose fibers have the tendency to hold the detergent.



Note: Speed

After selecting this function, user cannot select speed. But the machine will complete spinning process.

Function button “”

- Touch this button (Fig. 5-14) to select the network. If the machine does not have a distribution network, short press this button to start the distribution network.
- If the network is already connected, short pressing this button is for remote authorization.
- Long press this button to clear the distribution network information.
- Choose “” to enter network configuration mode, the Wi-Fi function will enable at the same time.
- After configuring the network successfully, press “” to authorize. The above steps can be operated on mobile application “APP”.

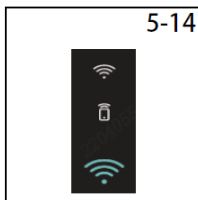

Function button “>||”

- Touch this button (Fig. 5-15) gently to start or interrupt the currently displayed programme.



Function button “”

- Press the speed and start/stop button (Fig. 5-16) simultaneously to activate the child lock mode.

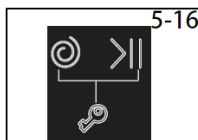

First starting

Language setting

- Power on the machine and press this button “>||” to set languages and sounds.
- To switch languages, rotating the knob and click “>||” to confirm your choice.
- Rotating the knob to turn on or off the beep sound, then click “>||” to confirm.

6. PROGRAMMES

- Yes
- Optional
- / No

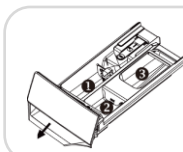

Detergent compartment for:

- 1 Detergent
- 2 Softener or care product
- 3 Prewash¹⁾

EN

		MAX KG		STD TEMP	MAX TEMP	PRESENT SPIN	MAX SPIN	1	2	3	WASH INTENSITY ²⁾	QUICK WASH	SILENT MODE	NO IRONING	EXTRA RINSE	REMOTE	DELAY
		8 KG	10 KG														
	ECO 40-60	8	10	40	90	1400	1400	●	○	○	○	○	○	○	○	○	○
	WHITES	4	5	30	60	1000	1000	●	○	○	○	○	○	○	○	○	○
	SMART WASH	4	5	40	60	1000	1000	●	○	○	/	○	/	○	○	○	○
	JEANS	8	10	30	60	1000	1000	●	○	○	○	○	○	○	○	○	○
	SYNTHETICS	4	5	40	60	1200	1200	●	○	○	○	○	○		○	○	○
	HAND WASH	1	2	30	60	800	800	●	○	/	/	/	○	○	○	○	○
	DRUM CLEAN	1	1	-	-	600	-	/	/	/	/	/	/	/	/	○	/
	DRAIN & SPIN	8	10	-	-	1000	1400	/	/	/	/	/	/	/	/	○	/
	SPECIAL 39'	2	2.5	30	30	800	1400	●	○	/	/	/	/	/	○	○	○
	RAPID	1	2	30	30	800	1400	●	○	/	/	/	/	/	/	○	○
	20 °C COLD WASH	8	10	20	20	1000	1000	●	○	/	○	○	○	/	○	○	○
	ANTI-POLLUTION	8	10	60	90	1400	1400	●	○	/	○	○	○	/	○	○	○
	HYGIENE PLUS 59'	1	2	60	90	1400	1400	●	○	/	○		○	/	○	○	○
	COTTON	8	10	40	90	1400	1400	●	○	○	○	○	○	○	○	○	○
	DELICATE	2	2.5	30	40	400	400	●	○	/	/	/	/	/	/	○	○
	RINSE	8	10	-	-	1000	1000	/	○	/	/	/	/	/	/	○	/

**INFORMATION FOR THE TEST LABORATORIES
STANDARD PROGRAMME ACCORDING TO (EU) No 2019/2023: ECO 40-60 PROGRAMME**

- 1) A little detergent can be added only with the pre-wash function.
- 2) This button also for selecting duration of rapid care and different steam intensities as explained in the dedicated paragraphs, but the light is not illuminated.

Description of programmes

To clean different types of fabrics and various levels of dirt, the washing machine has specific programs to meet every need of washing (see table of programmes).



Note:

Choose programme in accordance with the laundry instructions appearing on labels, especially the maximum recommended temperature.



WARNING!

IMPORTANT

PERFORMANCE ADVICE.

WASH

- New, coloured garments should be washed separately for at least 5 or 6 washes.
- Certain large dark items such as jeans and towels should always be washed separately.
- Never mix NON-COLOURFAST fabrics.

ECO 40-60

The ECO 40-60 programme is able to clean normally soiled cotton laundry declared to be washable at 40 °C or 60 °C, together in the same cycle. This programme is used to assess the compliance with the EU Ecodesign legislation (environmentally friendly products design).

WHITES

This programme is suitable for washing coloured cotton garments at 40 °C or for ensuring the highest degree of cleanliness for cotton resistant laundry washing at 60 °C or 90 °C. The final spin is at maximum speed that ensures excellent water removal.

SMART WASH

The new power care technology, through a perfect mix of water and detergent, guarantees the maximum care of your clothes, at a 30 °C temperature with a perfect washing performance. This innovative programme is capable to automatically the cleaning action to the capacity and typology of the load for the best results without any worries. This program can wash lightly soiled mixed laundry of cotton and synthetic.

JEANS

The perfect combination of time and performance. Created to eliminate dirt from athletic garments and sportswear. A low temperature wash recommended for small loads of synthetic items.

SYNTHETICS

This programme allows you to wash different fabrics and different colours all together. The rotation movement of the drum and the water levels are optimized, both during the washing rinsing phase. The accurate spin action ensures a reduced formation of creases in the fabrics.

HAND WASH

This programme performs a wash cycle dedicated to the delicate fabrics that can be washed the washing machine, the articles to be washed by hand.

DRUM CLEAN

This program can carry out the self-cleaning of the washing machine. We recommend a bucket self-cleaning after using the washing machine for 50 times. When using this program, please do not put any clothes detergent or machine cleaner.

DRAIN&SPIN

The program completes the drain and a maximum spin. It is possible to delete or reduce the spin through the spin selection button.

SPECIAL 39

This programme allows you to wash different fabrics together such as cottons, synthetics and mixed fabrics in only 39 minutes at 40 °C (or less) temperature. This programme is particularly suited to slightly dirty fabrics.

RAPID

This new programme may be used to obtain excellent results while saving water, energy, detergent and time. This option washes at a medium temperature suitable for lightly soiled mixed laundry of cotton and synthetic. Recommended for small loads and lightly soiled items.

20 °C NEW CYCLE

This innovative programme, allows you to wash different fabrics and colours together, such as cottons, synthetics and mixed fabrics at only 20 °C and provides an excellent cleaning performance.

EASY IRON

This programme uses a steam treatment to relax creases. Three different intensity levels can be selected via the button, designed only for dry garments and depending on the type of fabric.

HYGIENE PLUS 59

This washing programme is capable of reaching a temperature of 60 °C for an extended period of time, combining the steam action with a powerful rinsing action for thoroughly clean and hygienic clothing. Recommended for cotton fabrics.

COTTON

This programme is suitable for washing coloured cotton garments at 40 °C or for ensuring the highest degree of cleanliness for cotton resistant laundry washing at 60 °C or 90°C.

The final spin is at maximum speed that ensures excellent water removal.

DELICATE

Developed to take good care of delicate items, this programme washes at a low temperature in short time. An extended, in-depth rinse nourishes fabric fibres.

RINSE

This program performs 2 rinses with an intermediate spin (which can be reduced or excluded by using the appropriate button). It is used for rinsing any type of fabric, for example after a wash carried out by hand.



Note: The procedure to check the number of cycles that the machine has run

Procedure: under standby mode, select "DRAIN & SPIN" programme first, then press "speed" and "delay" at the same time. It will display the number of running cycle for 2 seconds, and then back to standby interface. The cumulative running cycles will add after the programme ends. The running cycles will be displayed in hexadecimal if it is over 9999.

7. CONSUMPTION





Scan QR code on energy label for energy consumption information.

The actual energy consumption may differ from the declared one according to local conditions.



Note: Auto Weight

The appliance is equipped with a loading recognition. At low loading, energy, water and washing time will be reduced automatically in some programmes. The display default time may vary depending on the load weight, involving the “Smart, Synthetic, Cotton, Cotton 20 °C, Eco 40-60” programme.

Rated Capacity	Programme	 (kg)	 (HH:MM)	ENERG ↓ (kWh/cycle)	 (L/cycle)	Max Temperature (°C)	Effective Speed (RPM)	 Residual Moisture (%)
8 kg (1400r)	Eco 40-60	8	3:48	0.760	68.0	35	1330	52.0
	Eco 40-60	4	2:52	0.550	43.0	33	1330	52.0
	Eco 40-60	2	2:52	0.230	35.0	25	1330	56.0
	Cotton 20 °C	8	1:58	0.220	80.0	20	1000	65.0
	Cotton 20 °C	8	3:03	2.300	80.0	57	1400	53.0
	Wool 30 °C	2	0:50	0.250	40.0	30	800	37.0
10 kg (1400r)	Eco 40-60	10	3:58	0.865	78.0	35	1330	52.0
	Eco 40-60	5	2:58	0.560	47.0	33	1330	52.0
	Eco 40-60	2.5	2:58	0.250	35.0	25	1330	56.0
	Cotton 20 °C	10	1:58	0.220	85.0	20	1000	65.0
	Cotton 20 °C	10	3:03	2.500	85.0	57	1400	53.0
	Wool 30 °C	2.5	0:50	0.300	45.0	30	800	37.0

The values given for programmes other than the Eco 40-60 programme and the wash and dry cycle are indicative only.

8. DAILY USE

Power supply

Connect the washing machine to a power supply (220V to 240V-/50Hz; Fig. 8-1). Please refer also to section <2. INSTALLATION>.

Water connection

- Before connecting, check cleanliness and clarity of the water inlet.
- Turn on the tap (Fig. 8-2).



Note: Tightness

Before use check for leakage in the joints between the tap and the inlet hose by turning on the tap.

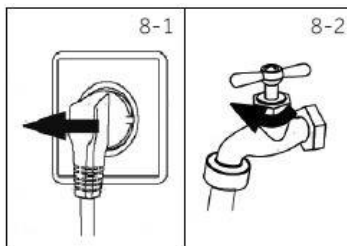

Preparing laundry

- Sort out clothes according to fabric (cotton, synthetics, wool or silk etc.) and how dirty they are (Fig. 8-3). Pay attention to the care labelling of washing labels.
- Separate white clothes from coloured ones. Wash coloured textiles first by hand to check if they fade or run.
- Empty pockets (keys, coins, etc.) and remove harder decorative objects (e.g. brooches).
- Garments without hems, delicates and finely woven textile such as fine curtains are to be put into a wash bag to care for this delicate laundry (hand or dry cleaning would be better).
- Close zippers, velcro fastener and hooks, make sure the buttons are sewn on tightly.
- Place sensitive items like laundry without firm hem, delicate underwear (Dessous) and small items such as socks, belts, bras. etc. in a wash bag.
- Unfold large pieces of fabric such as bed sheets, bedspreads etc.
- Turn jeans and printed, decorated or color intensive textiles inside out: possibly wash separately.

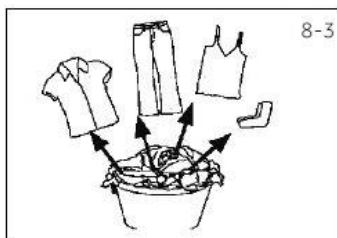

CAUTION!

Non-textile, as well as small, loose or sharp-edged items may cause malfunctions and damage of clothes and appliance.

Care chart

Washing

	Washable up to 95 °C normal process		Washable up to 60 °C normal process		Washable up to 60 °C mild process
	Washable up to 40 °C normal process		Washable up to 40 °C mild process		Washable up to 40 °C very mild process
	Washable up to 30 °C normal process		Washable up to 30 °C mild process		Washable up to 30 °C very mild process
	Wash by hand max. 40 °C		Do not wash		

Bleaching

	Any bleaching allowed		Only oxygen/ nonchlorine		Do not bleach
--	-----------------------	--	--------------------------	--	---------------

Drying

	Tumble drying possible normal temperature		Tumble drying possible lower temperature		Do not tumble dry
	Line drying		Flat drying		

Ironing

	Iron at a maximum temperature up to 200 °C		Iron at a medial temperature up to 150 °C		Iron at a low temperature up to 110 °C; without steam (steam ironing may cause irreversible damage)
	Do not iron				

Professional Textile Care

	Dry cleaning in tetrachloroethene		Dry cleaning in hydrocarbons		Do not dry clean
	Professional wet clean		Do not professional wet clean		

Loading the appliance

- Put in the laundry piece by piece.
- Don't overload. Note the different maximum load according to programmes! Rule of thumb for maximum load: Keep six inches between load and drum top.
- Close the door carefully. Make sure that no pieces of laundry are pinched.



Note: Auto Weight

The display default time may vary depending on the load weight, involving the "COTTONS, ECO 40-60, 20 °C, SYNTHETIC & COLOURED, ALLERGY CARE PRO, AUTO CARE, NIGHT & DAY" program.

Selecting detergent

- Washing efficiency and performance is determined by used detergent quality.
- Use only machine wash approved detergent.
- If needed use specific detergents, e.g. for synthetic and woolen fabric.
- See tips for countertop detergent stickers.
- Do not use dry cleaning agents such as trichloroethylene and similar products.

Choose the best detergent

Programme	Kind of detergent				
	Universal	Colour	Delicate	Special	Softener
SPECIAL 39'	L	L	—	—	○
ANTI-POLLUTION	—	—	—	—	—
RAPID	L	L	—	—	—
HYGIENE PLUS 59	—	—	○	○	○
DELICATE	—	—	○	○	○
SMART WASH	L/P	L/P	—	—	○
JEANS	—	—	○	○	○
RINSE	—	—	—	—	○
COTTON	L/P	L/P	—	—	○
ECO 40-60	L/P	L/P	—	—	○
HAND WASH	—	—	L/P	L/P	○
20 °C NEW CYCLE	L/P	L/P	—	—	○
SYNTHETIC	—	○	—	—	○
DRAIN&SPIN	—	—	—	—	—
WHITES	L/P	L/P	—	—	○
DRUM CLEAN	—	—	—	○	—

L = gel-/liquid detergent

P = powder detergent

○ = optional

— = no

We recommend using:

Laundry powder: 20 °C to 90 °C* (best use: 40-60 °C)

Color detergent: 20 °C to 60 °C (best use: 30-60 °C)

Wool/delicate detergent: 20 °C to 30 °C (best use: 20-30 °C)

- * Choose 90 °C wash temperature only for special hygienic requirements.
- * If you choose the water temperature 60 °C or above, we would like to advise you to use less detergent.
- * It is better to use less or free detergent powder.
- * Suggested detergent type on remote control depends on the program chosen on APP.

Adding detergent

1. Slide out the detergent drawer.
2. Put the required chemicals into corresponding compartments (Fig. 8-4).
3. Push back the drawer gently.



Note:

- Remove detergent residues before next wash cycle from the detergent drawer.
- Do not overuse detergent or softener.
- Please follow the instruction on the detergent package.
- Always fill the detergent just before the beginning of the wash cycle.
- Concentrated liquid detergent should be diluted before adding.
- Do not use liquid detergent if function “Delay” is selected.
- Carefully choose the programme settings according to the care symbols on all laundry labels and according to the programme table.

Select a programme

To get the best washing results, select a programme which fits the degree of soiling and sort of laundry type.

Turn the programme knob (Fig. 8-5) to select the right programme. The display will show the selected programme name.



Note: Odour removal

Before first use we recommended to run programme “DRUM CLEAN” to remove possibly corruptive residues. Please don't put any detergent or special machine cleaner in washing agent compartment (2).

Add individual selections

Select required options and settings (Fig. 8-6): refer to Control Panel.

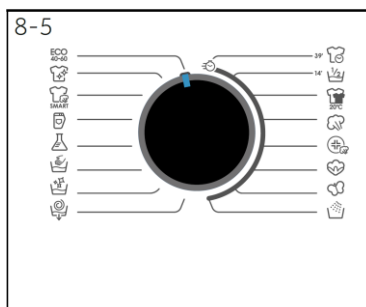
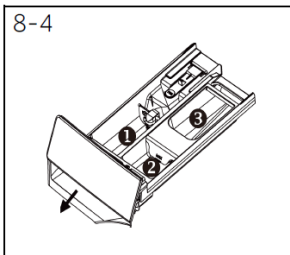

Start wash programme

Touch “Start/Pause” button (Fig. 8-7) to start. Appliance operates according to present settings. Changes are only possible by cancelling the programme.

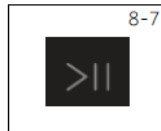

Interrupt / cancel wash programme

To interrupt a running programme, press gently “Start/Pause”. The LED above the button is flashing. Press it again to resume operation.

To cancel a running programme and all its individual settings:

1. Touch “Start/Pause” button to interrupt the running programme.
2. Turn the knob to the programme DRAIN & SPIN and select “NO SPIN” to drain the water
3. After closing the programme to restart the appliance, select a new programme and start it.
4. After closing the programme to restart the appliance, select a new programme and start it.

After washing



Note: Door lock

- For safety reasons the door is locked partially during the washing cycle. It is only possible to open the door at the end of the programme or after the programme was cancelled correctly (see description above).
- In case of high water level, high water temperature and during spinning it is not possible to open the door: Lock is displayed.

1. At programme cycle END is displayed.
2. The appliance switches off automatically.
3. Remove laundry as soon as possible to go easy on it and to prevent more wrinkling.
4. Turn off the water supply.
5. Unplug the power cord.
6. Open the door to prevent formation of moisture and odours. Let it open while not used.



Note: Standby-mode / energy-saving mode

The switched-on appliance will go into standby-mode if it will not be activated within 2 minutes before starting the programme or at the end of the programme, except REMOTE CONTROL. The display switches off. This saves energy. To interrupt the standby mode, turn the knob to any other programme except “OFF”.

Activate or deactivate the buzzer

The acoustic signal can be deselected if necessary:

1. In the standby mode after power on, long press the button “OPTION” for more than 5S to turn off the sound. The interface will display “SOUND OFF”. Press and hold this key again for more than 5S. and the interface will “SOUND ON”.

9. REMOTE CONTROL (WI-FI)

General

This appliance is equipped with Wi-Fi technology that allows you to control it remotely via App.



WARNING!

Please observe the safety precautions in this user manual and make sure that these are complied even when operating the appliance via the hOn APP while you are away from home. You must also follow the instructions in the hOn.

Requirements

1. One wireless router (802.11b/g/n protocol) which supports only the frequency band of 2.4 GHz. Length of Router SSID is 1-31 characters (including 1 and 31). and password is 8-64 characters. Minimum length of password must be 8 characters. Router encryption methods include open, WPA-PSK and WPA2-PSK.
2. The App is available for devices running Android. Huawei or iOS, both for tablets and for smartphones.
3. The appliance shall be installed in a position where it can receive a strong Wi-Fi signal. Once the appliance has been correctly associated with the APP, if it's not properly connected to the wireless router, no Wi-Fi icon appears on the display.

Download and installation of hOn APP

Download the hOn App on your device by framing the following QR code:



Download the App



or by the link: go.haier-europe.com/download-app

Frequency rate (OFR)	2400 MHz - 2483.5 MHz
Max. power (EIRP)	20dBm
Wireless standard	IEEE802.11b/g/n & BLE V4.2



Note: Registration

Registration is required when first time to use or the formal account has been deleted/ closed. For further use, you need to enter user name and password when you log in.

Appliance pairing (on app)

1. The App is available for devices running both Android and iOS. both for tablets and for smartphones.
2. Get all the details of the Wi-Fi functions by browsing the Appin DEMO mode.
3. The frequency of the home Wi-Fi network has to be set on the 2.4 GHZ band. You cannot configure the machine if your home network is set to the 5 GHZ band.
4. Open the App. create the user profile (or log-in if it is already created previously) and pairing the appliance following the instructions on the device display.



Note: Wi-Fi network

It's not possible to connect the appliance to a public Wi-Fi network. It may cause malfunction.



Note: Use same Wi-Fi

Connect with your smartphone to the network you want to connect the product to.

To enable remote control

1. Check that the router is switched on and connected to the Internet.
2. Load the laundry, close the door, add the detergent if it's necessary.
3. Turn the programme selector to the REMOTE CONTROL (Wi-Fi) position
 
4. The door will lock and the controls on the control panel will be disabled.
5. Start the cycle using the app. When the cycle has been completed, turn off the machine by turning the programme selector to the OFF position to unlock the door.



Note: Remote control expiration

Once the remote control is activated, if the end user doesn't start any cycle from app in 10 minutes, the appliance will go to Networked Standby Mode, and keeps remote control up to 24 hours, then shut off.

To disable remote control

1. To exit REMOTE CONTROL mode while a cycle is underway, turn the programme selector to any position other than REMOTE CONTROL (Wi-Fi), without going through the OFF. The control panel on the appliance will be operative once again, and if the cycle is paused, you will be able to open the door once the DOOR LOCKED indicator light switches off.
2. For safety reasons, in some wash cycle phases, the door can be opened only if the level of the water is below its lower edge and if the temperature is below its lower edge. If these conditions are met. wait for the DOOR LOCKED light to switch off before opening the door.
3. With the door closed, turn the knob to the REMOTE CONTROL (Wi-Fi) position to control the appliance using the app once again. If there is a cycle underway, it will continue.

10. CARE AND CLEANING

Cleaning the detergent drawer

Take always care there are no detergent residues. Clean the drawer regularly (Fig. 10-1):

1. Pull out the drawer until it stops.
2. Press the release button and remove the drawer.
3. Flush the drawer with water until it is clean and insert the drawer back in the appliance.

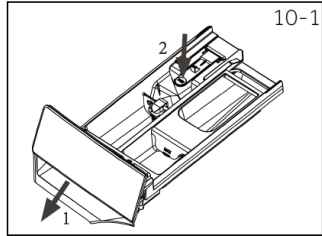

Cleaning the machine

- Unplug the machine during cleaning and maintenance.
- Use a soft cloth with soap liquid to clean the machine case (Fig. 10-2) and rubber components.
- Do not use organic chemicals or corrosive solvents.



Water inlet valve and inlet valve filter

To prevent blockage of water supply by solid substances like lime clean regularly the inlet valve filter.

- Unplug the power cord and turn off the water supply.
- Unscrew the water inlet hose at the back (Fig. 10-3) of the appliance as well as on the tap.
- Flush the filters with water and a brush (Fig. 10-4).
- Insert the filter and install the inlet hose.

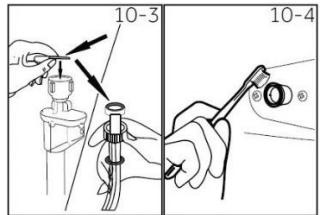

Cleaning the drum

- Remove accidentally washed items, especially metal parts such as pins, coins, etc. from the drum (Fig. 10-5) because they cause rust stains and damage.
- Use a non-chloride cleaner for removing rust stains. Observe the warning hints of the cleaning agent manufacturer.
- Do not use any hard objects or steel wool for cleaning.

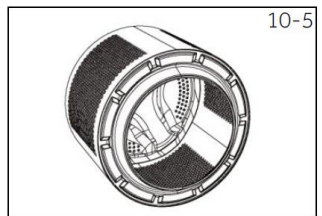

Long periods of disuse

If the appliance is left idle for a longer period:

1. Pull out the electrical plug (Fig. 10-6).
2. Turn off water supply (Fig. 10-7).
3. Open the door to prevent formation of moisture and odours. Let the door open when not in use.

Before next usage, check the power cord, water inlet and drain hose carefully. Make sure that everything is properly installed and without leakage.

Pump filter

Clean the filter once a month and check the pump filter for instance if the appliance:

- Doesn't drain water.
- Doesn't spin.
- Cause unusual noise while running.



WARNING!

Scalding Risk! Water in the pump filter can be very hot! Before any action please ensure water has cooled down.

1. Turn off and unplug the machine (Fig. 10-8).
2. Push and open the filter door (Fig. 10-9).
3. Provide a flat container to catch leach water (Fig. 10-10). There could be bigger amounts.
4. Pull the drain hose out and hold its end above the container (Fig. 10-10).
5. Taking the sealing plug out of the drain hose (Fig. 10-10).
6. After completing drainage, close the drain hose and push it back to the machine (Fig. 10-11).
7. Unscrew and remove the pump filter counter clockwise (Fig. 10-12).
8. Remove contaminants and dirt (Fig. 10-13).

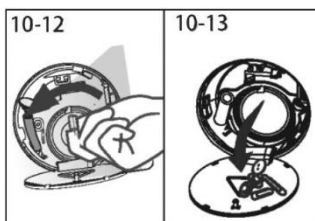
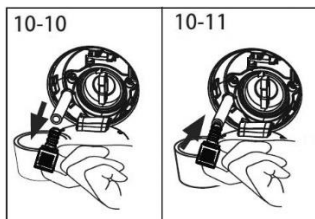
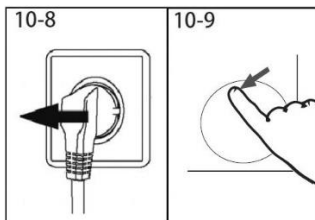
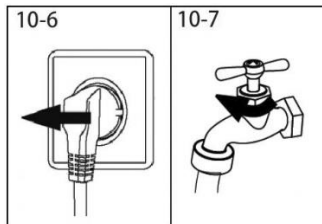

9. Clean carefully pump filter, e.g. using running water (Fig. 10-14).
10. Refix it thoroughly (Fig. 10-15).
11. Close service flap.



CAUTION!

- Pump filter sealing has to be clean and unhurt. If the lid is not full tightened, water can escape.
- The filter must be in place, or it may lead to leakage.

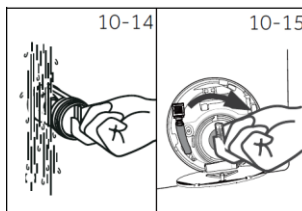

11. TROUBLESHOOTING

Many occurring problems could be solved by yourself without specific expertise. In case of a problem please check all shown possibilities and follow below Instructions before you contact an after sales service. See <13. CUSTOMER SERVICE>.



WARNING!

- Before maintenance, deactivate the appliance and disconnect the mains plug from the mains socket.
- Electrical equipment should be serviced only by qualified electrical experts, because improper repairs can cause considerable consequential damages.
- A damaged power cable should only be replaced by the manufacturer, its service agent or similarly qualified persons in order to avoid a hazard.

Information codes

Following codes are displayed only for information referring to the washing cycle. No measures must be performed.

Code	Message
1:25	The remaining wash cycle time will be 1 hour and 25 minutes.
6:30	The remaining delay time will be 6 hours and 30 minutes.
CLOF	Function child lock is activated.
End	The washing cycle is finished. The appliance shuts off automatically.
Lock	Door is closed because of high water level, high water temperature or spinning cycle.

Troubleshooting with display code

Problem	Cause	Solution
CLR FLTR	<ul style="list-style-type: none"> • Drainage error, water is not fully drained within 6 minutes. 	<ul style="list-style-type: none"> • Clean pump filter • Check drain hose installation.
E2	<ul style="list-style-type: none"> • Lock error. 	<ul style="list-style-type: none"> • Shut the door properly.
E4	<ul style="list-style-type: none"> • Water level not reached after 12 minutes. • Drain hose is self-syphoning. 	<ul style="list-style-type: none"> • Make sure that tap is fully opened and water pressure is normal. • Check drain hose installation.
E8	<ul style="list-style-type: none"> • Water protective level error. 	<ul style="list-style-type: none"> • Contact the After sales service.
F3	<ul style="list-style-type: none"> • Temperature sensor error. 	<ul style="list-style-type: none"> • Contact the After sales service.
F4	<ul style="list-style-type: none"> • Heating error. 	<ul style="list-style-type: none"> • Contact the After sales service.

Problem	Cause	Solution
F7	<ul style="list-style-type: none"> Motor error. 	<ul style="list-style-type: none"> Contact the After sales service.
FA	<ul style="list-style-type: none"> Water level sensor error. 	<ul style="list-style-type: none"> Contact the After sales service.
FC0, FC1 or FC2	<ul style="list-style-type: none"> Abnormal communication error. 	<ul style="list-style-type: none"> Contact the After sales service.
FH	<ul style="list-style-type: none"> The iot module fails to be configured. 	<ul style="list-style-type: none"> Contact the after sales service to replace the iot module.
E5	<ul style="list-style-type: none"> Drainage error. 	<ul style="list-style-type: none"> Water is not fully drained in set time.
Eb	<ul style="list-style-type: none"> Clothes jamming alarm. 	<ul style="list-style-type: none"> Pause operating, open the door and place garments again before restarting.

Troubleshooting without display code

Problem	Cause	Solution
Washing machine fails to operate.	<ul style="list-style-type: none"> Programme is not yet started. Door is not properly closed. Machine has not been switched on. Power failure. Child lock is activated. 	<ul style="list-style-type: none"> Check programme and start it. Close the door properly. Switch the machine on. Check power supply. Deactivate child lock.
Washing machine will not be filled with water.	<ul style="list-style-type: none"> No water. Inlet hose is kinked. Inlet hose filter is blocked. Water pressure is less than 0.03 MPa. Door is not properly closed. Water supply failure. 	<ul style="list-style-type: none"> Check water tap. Check inlet hose. Unblock inlet hose filter. Check water pressure. Close the door properly. Ensure the water supply.
Machine is draining while being filled.	<ul style="list-style-type: none"> Height of drain hose is below 80 cm. Drain hose end could reach into water. 	<ul style="list-style-type: none"> Make sure that drain hose is properly installed. Make sure the drain hose is not in water.
Drainage failure.	<ul style="list-style-type: none"> Drain hose is blocked. Pump filter is blocked. Drain hose end is higher than 100 cm above floor level. 	<ul style="list-style-type: none"> Unblock drain hose. Clean pump filter. Make sure that drain hose is properly installed.
Strong vibration while spinning.	<ul style="list-style-type: none"> Not all transportation bolts have been removed. Appliance has no solid position. Machine load is not correct. 	<ul style="list-style-type: none"> Remove all transportation bolts. Ensure solid ground and a levelled position. Check load weight and balance.
Operation stops before completing wash cycle.	<ul style="list-style-type: none"> Water or electric failure. 	<ul style="list-style-type: none"> Check power and water supply.
Operation stops for a period of time.	<ul style="list-style-type: none"> Appliance displays error code. Problem due to load pattern. Programme performs soaking cycle. 	<ul style="list-style-type: none"> Consider display codes. Reduce or adjust load. Cancel programme and restart.
Excessive foam floats drum and/or detergent drawer.	<ul style="list-style-type: none"> Detergent is not appropriate. Excessive use of detergent. 	<ul style="list-style-type: none"> Check detergent recommendations. Reduce amount of detergent.
Automatic adjustment of washing time.	<ul style="list-style-type: none"> Washing programme duration will be adjusted. 	<ul style="list-style-type: none"> This is normal and doesn't affect functionality.
Spinning fails.	<ul style="list-style-type: none"> Unbalance of laundry. 	<ul style="list-style-type: none"> Check machine load and laundry and run a spinning programme again.

Problem	Cause	Solution
Unsatisfactory washing result.	<ul style="list-style-type: none"> Degree of pollution does not agree with selected programme. Detergent quantity was not sufficient. Maximum load has been exceeded. Laundry was unevenly distributed in the drum. 	<ul style="list-style-type: none"> Select another programme. Choose the detergent acc. to the degree of pollution and according to manufacture. Reduce loading. Loose the laundry.
Washing powder residues are on the laundry.	<ul style="list-style-type: none"> Insoluble particles of detergent can remain as white spots on the laundry. 	<ul style="list-style-type: none"> Perform extra rinse. Try to brush the points from the dry laundry. Choose another detergent.
Laundry has grey patches.	<ul style="list-style-type: none"> Caused by fats such as oils, creams or ointments. 	<ul style="list-style-type: none"> Pretreat the laundry with a special cleaner.



Note: Foam formation

If too much foam is inspected during spin cycle, motor stops and drain pump will be activated for 90 seconds. If that elimination of foam fails up to 3 times, programme ends without spinning.

Should the error messages reappear even after the taken measures, switch off the appliance, disconnect the power supply and contact the customer service.

In case of power failure

The current programme and its setting will be saved. When power supply is restored, operation will be resumed.

If a power failure cuts an operating wash programme door opening is mechanically blocked. To get out any laundry water level should not be seen in the glassy porthole of the door. Danger of burns! Water level has to be lowered as described in <PUMP FILTER>. Not till then pull lever (A) beneath service flap (Fig. 11-1) until door is unlocked by a gentle click. Afterwards refix all parts.

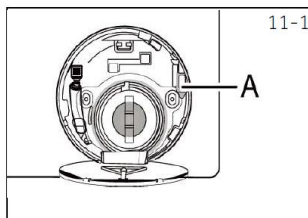

Note:

When the washing machine in a safe state (under the water level below the window along a certain distance, barrel temperature below 55 °C. the inner barrel did not turn), may unlock the doors of the machine operation.

12. TECHNICAL DATA

Additional technical data

	RT48*	RT410*
Voltage in V	220-240 V~/50Hz	
Current in A	10	
Max power in W	1900	
Water pressure in MPa	0.03≤P <1	
Net weight in kg	XX	XX

Product dimensions

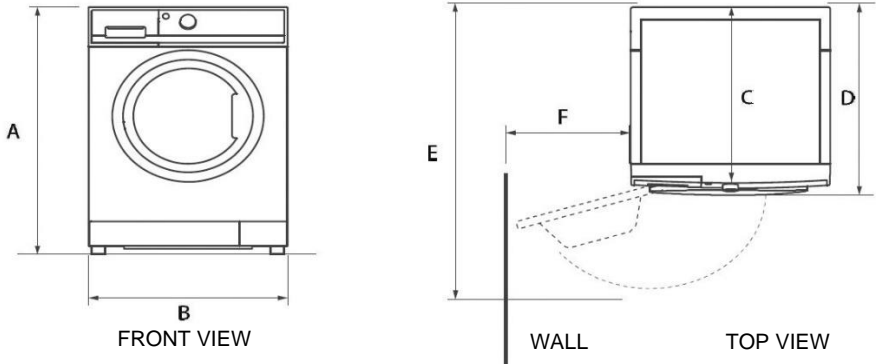

PRODUCT DIMENSIONS	RT48*	RT410*
A Overall height of product mm	850	850
B Overall width of product mm	595	595
C overall depth of product (to main control board size) mm	XXX	XXX
D Overall depth of product mm	XXX	XXX
E Depth of door open mm	XXX	XXX
F Minimum door clearance to adjacent wall mm	XXX	XXX



Note:

The exact height of your washer is dependent on how far the feet are extended from the base of the machine. The space where you install your washer needs to be at least 40 mm wider and 20 mm deeper than its dimensions.

Standards and Directives

This product meets the requirements of applicable EC directives with the corresponding harmonised standards, which provide for CE marking.

13. CUSTOMER SERVICE

We recommend our Candy Customer Service and the use of original spare parts. If you have a problem with your appliance, please first check section <11. TROUBLESHOOTING>.

If you cannot find a solution there, please contact:

- your local dealer.
- the Assistance Area on the Candy website where you can find information on Warranties, Accessories and Spare Parts and Contact numbers.

To contact our Service, ensure that you have the following data available.

Each product is identified by a unique code, also called the "serial number", printed on a sticker. This can be found inside the door opening.

Model _____ Serial No. _____

Also check the Warranty Card supplied with the product in case of warranty.

It is always recommended to use original spare parts, that are available at our Authorised Customer Service Centres.

Warranty

The product is guaranteed under the terms and conditions stated on the certificate included with the product. The certificate has to be stored so as to be shown to the Authorized Customer Service Centre in case of need. You can also check the warranty conditions on our web site. To obtain assistance, please fill in the form on-line or contact us at the number indicated on the support page of our web site.

The standard manufacturer warranty covers faults caused by electrical or mechanical faults in the product due to an act or omission of the manufacturer. If a fault is found to be caused by factors outside the product supplied, miss-use or as a result of the instructions on use not being followed, a charge may be applied.

The manufacturer declines all responsibility for any printing errors in the booklet included with this product. Moreover, it also reserves the right to make any changes deemed useful to its products without changing their essential characteristics.

23.10 - 002050928 8 XX -